

Model BD505

Includes Basin Filter Model B6P

Model BS505

Includes Pumpout Filter Model PUM11

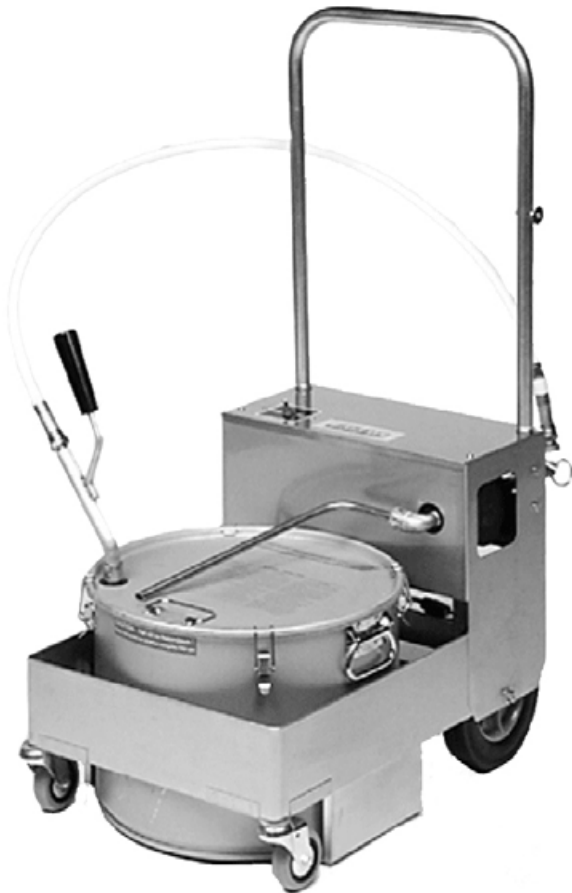

Model BD707

Includes Basin Filter Model C88P

Model BS707

Includes Pumpout Filter Model PUM11



Model BD505 & BS505

Do Not Exceed Rated oil Capacity of 55 lbs (7.5 gallons)

Model BD707 & BS707

Do Not Exceed Rated oil Capacity of 80 lbs (11 gallons)

MIROIL Division of Oil Process Systems Inc.
602 North Tacoma Street Allentown, Pennsylvania 18109
PHONE: 610 437-4618 FAX: 610 437-3377 E-mail: info@miroil.com Web: www.miroil.com

"Heads Above the Rest"

30 Years
1973 - 2003

Dear Customer:

Congratulations on your selection of our High Performance Power Filter Machine which continues over 30 years of leadership in oil management.

Your Filter Machine is an important tool for fryer oil management. It is designed to achieve maximum performance for removal of fine crumb and food materials at the lowest cost.

Another important part of oil management is **fryliquid™ antioxidant**. When you use this product with your filter machine you will experience enhanced oil performance and enhanced food quality. This combination delivers benefits not available from other filter machines.

- Provides consistent and enhanced food quality
- Oil savings from 25% to 40%
- Fryers stay free of carbon and gum deposits
- The MirOil filter does not leach harmful chemicals like paper filters
- Faster set-up and clean-up will save on labor
- Throw-away paper filters, D. E. powder or expensive cartridges are not needed.
- MirOil "Rinse & Reuse" filter bags clean up in seconds under hot water spray.

Why fryliquid™ antioxidant and your filter machine deliver these benefits.

All oil breakdown substances are liquid. They pass through filters and filter aids and remain in the oil. As they accumulate, they undermine the nutritional profile and the cooking performance of the oil. **fryliquid™ antioxidant** prevents these breakdown liquid substances from forming in the oil.

This is why **fryliquid™ antioxidant** is able to provide total control of food quality and oil performance. **fryliquid™ antioxidant** prevents off flavors and odors. **fryliquid™ antioxidant does not react** with the oil or with the food.

To receive the full benefit from your MirOil Filter Machine, just follow these simple rules.

1. Set up a regular schedule to filter once a day.
2. Add **fryliquid™ antioxidant** to your oil before each meal session.
3. Follow the filtering and freshening procedures outlined in this manual.

For questions about **fryliquid™ antioxidant** or your **Power Filter Machine...**

Frying Hot Line 800.523.9844

Additional Tips

Order a spare filter bag so you are prepared if it may be required in the future.

If the oil for discard is held overnight in the kitchen for security reasons or if you need a measure for the freshening oil.... Order a Model 30LG utility pail - for measuring and / or storing up to 5 gallons of oil.



Division of Oil Process Systems Inc.

602 North Tacoma Street Allentown, Pennsylvania 18109

PHONE: 610 437-4618 FAX: 610 437-3377 E-mail: info@miroil.com Web: www.miroil.com

Loss or Damage During Shipment

Inspect all cartons for damage before unpacking. Your MirOil pump was thoroughly inspected before leaving our factory. The carrier is responsible for safe delivery. All claims for any loss or damage in transit must be made to the carrier. MirOil will assist with claims IF damage has been promptly reported to the carrier.

1 Year Limited Warranty on your Filter Machine

This product is warranted only against defects in workmanship or materials for 1 year from date of the filter machine is placed in service or not longer than 15 months from date of purchase. Liability under the basic 1 year limited warranty is limited to replacing or repairing parts FOB Allentown PA. Parts must be returned to our factory with shipping costs prepaid. ***The 1 year warranty does not cover the costs of service labor or shipping to replace parts.***

The use of the filter pump for pumping any liquid other than fryer oil will contaminate the pump and piping. This will contaminate the oil and may void this warranty

6 month Limited Warranty on your Filter Bag

The filter bag has a pro rata warranty for 6 months. This is similar to a warranty for a battery or tire. The filter bag must be returned to MirOil for repair, FOB Allentown, PA 18109. If the filter bag is not able to be repaired, it will be replaced with a new filter bag at the prevailing cost. Credit toward the purchase of the new filter bag will be provided for the unused service life of the old filter bag. This warranty does not cover the costs shipping to replace parts.

Important Limits for Coverage Under All Warranties

No warranty described above covers the replacement of parts that become inoperative because of wear (except filter bags) or abuse or for parts subjected to abuse/misuse, negligence, accident or if the product has been improperly repaired or altered by user or a 3rd party. No other warranty, expressed or implied, is authorized to be made by any parties on behalf of MirOil.

The manufacturer and the manufacturer's sales agents and/or agencies accept no liability for the use or misuse of this machine. Expressly excluded from warranty are implied warranties of merchantability and fitness for purpose. Manufacturer, agents and sales agencies disclaim all liability for accidents resulting from use or the misuse of this equipment.

Toll Free Call for warranty information 1.800.523.9844

Manual Reset Switch:

Manual reset thermal protector. The thermal protector will open the motor circuit if the motor overheats. If this happens, disconnect the power cord and turn switch off.

AFTER THE MOTOR COOLS, PUSH THIS RESET BUTTON. A CLICK INDICATES THAT IS HAS RESET AND THE MOTOR CAN BE RESTARTED.

If your oil / fat is solid at room temperature:

If a plug of solid fat or shortening forms in the hose, it will prevent pumping.

Procedure to prevent plug of solid oil, fat or shortening:

The oil film on the inside wall may collect at a loop in the hose and form a plug of solid fat. This will prevent the pump from priming. After filtering, disconnect the discharge hose and hang it from a hook to drain. Use a small collector pan or place hose nozzle in holder tube on Mobility Basin to avoid oil dripping on the floor.

Procedure for correcting blockage from plug of solid fat:

Unplug the electric cord. Try to pour some water through the discharge hose. If the water will not pass through the hose it is blocked with fat. Melt the fat plug by placing the hose in a large tub or sink with hot water.

Safety Caution:

Residue of water in the hose can cause a dangerous splatter of hot oil.

After the fat plug is melted, make sure the water is fully drained before the hose is recoupled. Before turning ON the power filter always make sure the discharge hose nozzle is directed at the fryer. If the pump is still not primed, allow the pump to run for about 3 to 5 minutes so the pump heat may melt any residue of fat in or near the pump body.

Safety first - Make sure the hose nozzle is in the holder tube on the Pump Module when the pump is running.

The following parts are included for assembly BD505/707

Handle Assembly

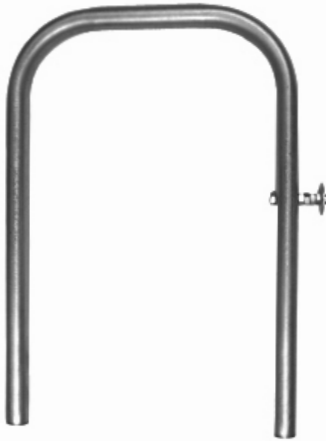

Discharge Hose Assembly



Suction Tube



**High Performance Filter
Model RB6P Filter Assembly**



**fryliquid™
Antioxidant**



**Drain Down Filter for heavy crumb loads
BD505B includes
Model D905A Filter Assembly**



**Drain Down Filter for heavy crumb loads
BD707B includes
Model F919A Filter Assembly**



Assembly of Models BD505 & BD707

Attach the discharge hose to the pump module. (a)

Use attached safety pin to keep the lever arms in locked position.

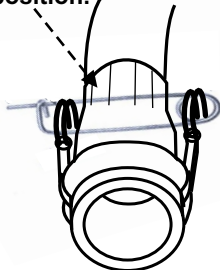

Pull on coupler to insure proper attachment.

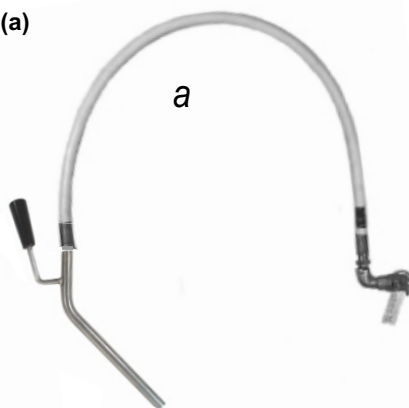

The following parts are included for assembly BS505/707

Handle Assembly

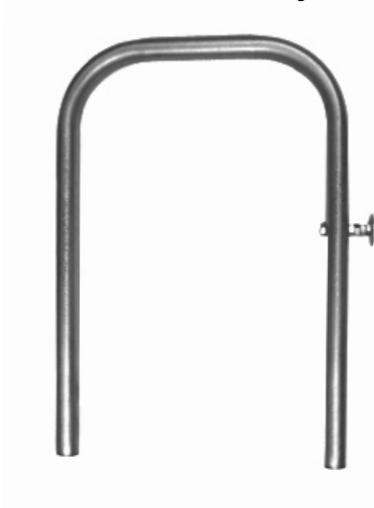

Discharge Hose Assembly



Suction Tube

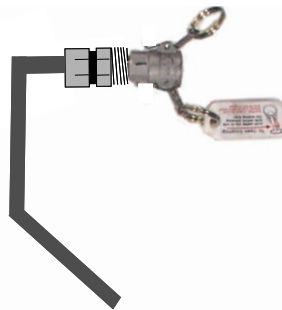

**Filter for counter top fryers with heavy crumb loads
BS505 & BS707 includes
Model PUM11A Filter Assembly**

Assembly of Models BS505 & BS707

Attach the discharge hose to the pump module. (a)

Use attached safety pin to keep the lever arms in locked position.

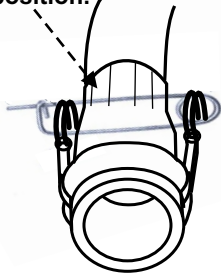

Pull on coupler to insure proper attachment.

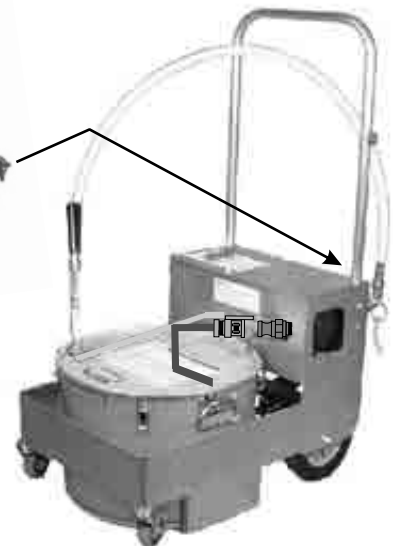
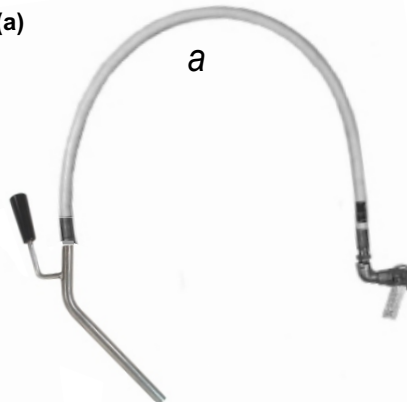

Filter Procedure for BD Series For use with fryers with drain valves.

CAUTION: Turn the switch to the OFF position before plugging in the power cord.
When you attach the hose. Pull hard on the hose to make sure the coupler lever arms are locked.
Make sure hose nozzle is in the nozzle holder on the pump.

Filter oil at temperatures from 300°F (148°C) to 350°F (176°C)

Step 1- Place EZ Flow Filter in the Basin.

Carefully open the fryer valve to drain oil into the filter basin through the filter bag.

Step 2- Close drain valve. Turn switch ON to pump the oil back to the fryer

Step 3- You may discard heavy crumb load before filtering the next fryer. Use a bus tray or carton to allow the crumb to cool because hot crumb will melt plastic garbage can liners.

Clean your filter under hot water spray. Store the filter in the filter basin to avoid accidental damage.

Do not wash the filter in a dishwasher or use soap. The least residue of soap is harmful to the oil.

There is NO need to remove filter bag from holder / frame to clean.

If solid shortening is used, uncouple and hang the hose so it drains fully to prevent fat from collecting and at a loop or bend of the hose where it may solidify as a fat plug.

More notes for great fried food:

1. Add *fryliquid*[™] antioxidant to your oil after filtering and/or before each meal session. This will capture oil breakdown substances as they form in the oil and prevent oil breakdown reactions.
2. When *fryliquid*[™] antioxidant is used, filter once a day unless crumb load is extremely heavy.
3. Follow the filtering and freshening procedures described in your brochure for *fryliquid*[™] antioxidant and the New Frying Technology to choose an oil management program for your fry station.

For assistance call . . . 1.800.523.9844

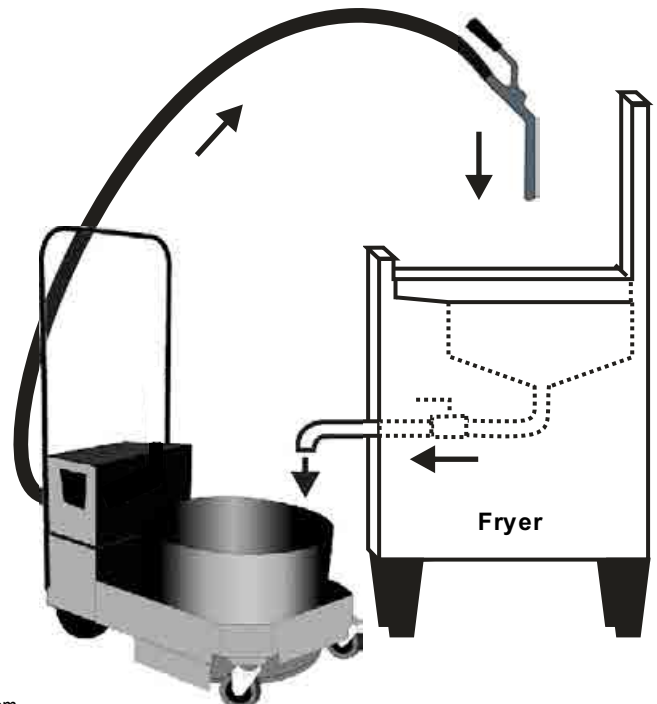

Filter Procedure for BS Series For counter top fryers with lift out fry pans (No drain valves)

If you also have fryers with drain valves, purchase a D Series Drain Filter for this filter machine.

Use the Filter Procedure for "D" Series for fryers with drain valves

CAUTION: Turn the switch to the OFF position before plugging in the power cord.

When you attach the hose. Pull hard on the hose to make sure the coupler lever arms are locked.

Make sure hose nozzle is in the nozzle holder on the pump.

Lift heaters out of the oil and secure them in this position.

Filter oil at temperatures from 300°F (148°C) to 350°F (176°C)

See diagram on bottom of this page:

Step 1 - Immerse the Pump-Out Filter carefully into the oil in the fry pan.

Install the hose nozzle into the nozzle holder tube of the Pump Out Filter.

Step 2 - Do not tilt the fryer pan to pump the residue of oil.

Adjust the height of the bottom of the nozzle to leave the proper amount of oil in the fry pan for freshening.
Discard this left over oil with the crumb.

This controlled discard will take the place of the Partial Discard Procedure of the Frying Program.

Step 3 - Rinse the fry pan only with hot water - no soap.

Step 4 - Turn switch to "PUMP OIL TO FRYER" to pump the oil back to the fry pan.

Do not wash the filter in a dishwasher or use soap. The least residue of soap is harmful to the oil.

If solid shortening is used, uncouple and hang the hose so it drains fully to prevent fat from collecting and at a loop or bend of the hose where it may solidify as a fat plug.

More notes for great fried food:

1. Add *fryliquid*TM antioxidant to your oil after filtering and/or before each meal session. This will capture oil breakdown substances as they form in the oil and prevent oil breakdown reactions.
2. When *fryliquid*TM antioxidant is used filter once a day, unless crumb load is extremely heavy.
3. Follow the filtering and freshening procedures described in your brochure for *fryliquid*TM antioxidant and the New Frying Technology to choose an oil management program for your fry station.

For assistance call . . . 1.800.523.9844

